

# Results

Q4 of 2013/14

Financial Year 2013/14

Media and Analyst Conference  
Zurich, 4 June 2014



# Agenda

## 1. LEM at a Glance

**François Gabella**

## 2. Highlights and Business Review

François Gabella

## 3. Financial Review

Julius Renk

## 4. Strategy and Outlook

François Gabella

## 5. Proposals to Shareholders Meeting

Andreas Hürlimann



2

# 1. Global Market Leader in Current and Voltage Transducers

## Market Position

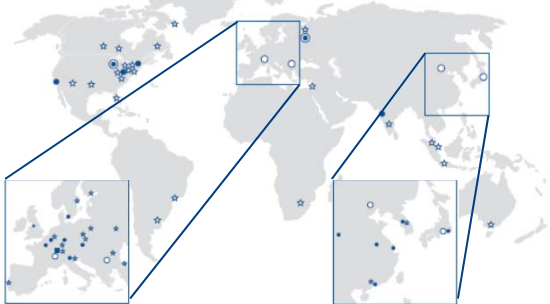

- Global market share of 50% in Industry
- Benchmark in service and product quality
- 4 production sites in Europe and Asia
- Sales of CHF 245.6 million in 2013/14

## Performance

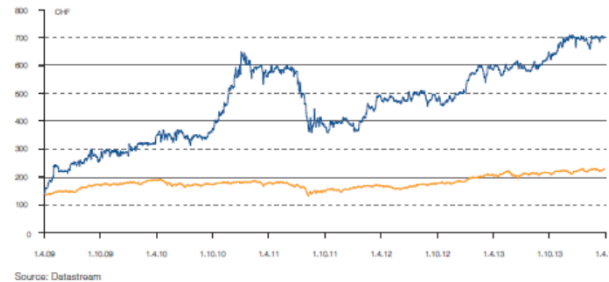

- Continued sales growth and margin improvements
- Dividend yield >5% in each year since 2009

## Perspectives



- Reinforced investment in innovation
- Solid growth perspectives due to underlying trends
- Strong foothold in China
- EBIT margin target of 15 to 20%

3

# 1. LEM Applications: Hybrid Loader

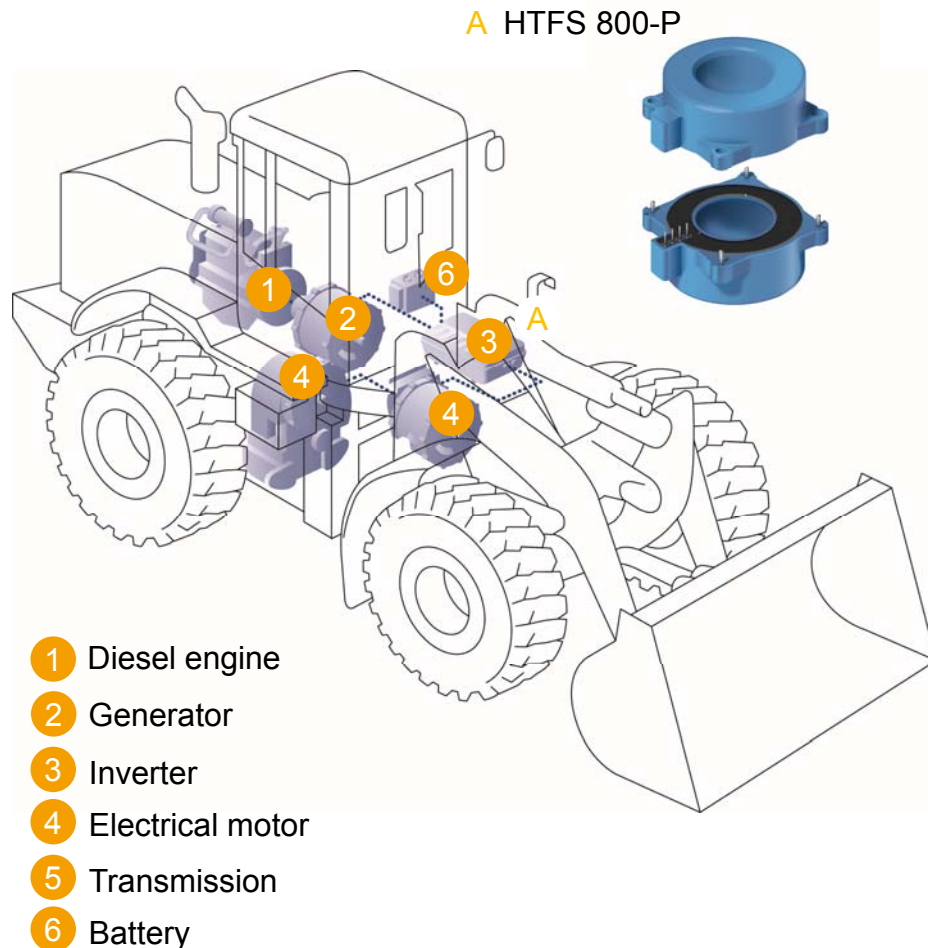

A hybrid loader boosts fuel economy by up to 25%, increases the system performance and is half as loud as a conventional loader.

The special internal combustion engine (1) drives an AC generator (2) for the bucket moves. The generator converts the engine's mechanical energy into electrical energy, which is converted by the inverter (3) to supply the electrical motor (4) to drive the transmission and the wheels.

The currents are measured with current transducers (A) to control the inverter. The accuracy of the current measurements allows to maximize the motor torque and overall motor efficiency. The transducers also enable the control system to sense over-current situations signaling a potential defect.

# 1. LEM Applications: Formula 1 Energy Recovery System

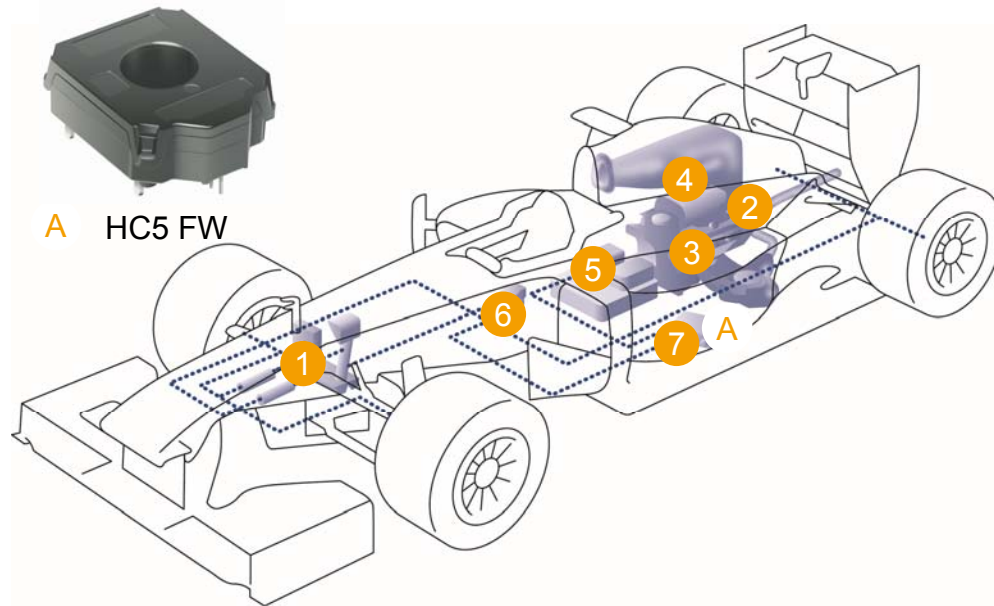

- 1 Pedals (accelerator, break)
- 2 Turbocharger
- 3 MGU-K
- 4 MGU-H
- 5 Battery
- 6 ERS break pressure valve
- 7 Engine control unit

2014 Formula 1 cars include a revised energy recovery system (ERS). Engine specifications impose a 440 kW turbocharged (2) engine combined with an ERS (3, 4) providing additional 120 kW for over 30 seconds per lap.

The ERS uses two distinct energy sources to provide the extra power: kinetic energy from braking and thermal energy from the exhaust gases. The energy is converted into electricity. The electricity is fed into a battery (5) and controlled by the ERS control unit (7).

LEM's HC5 FW (A) family of automotive current transducers measure the electric currents generated by each source, and allow the control unit to make the best decision of how and where to direct the available power.

5

# 1. LEM Applications: Roller Coaster

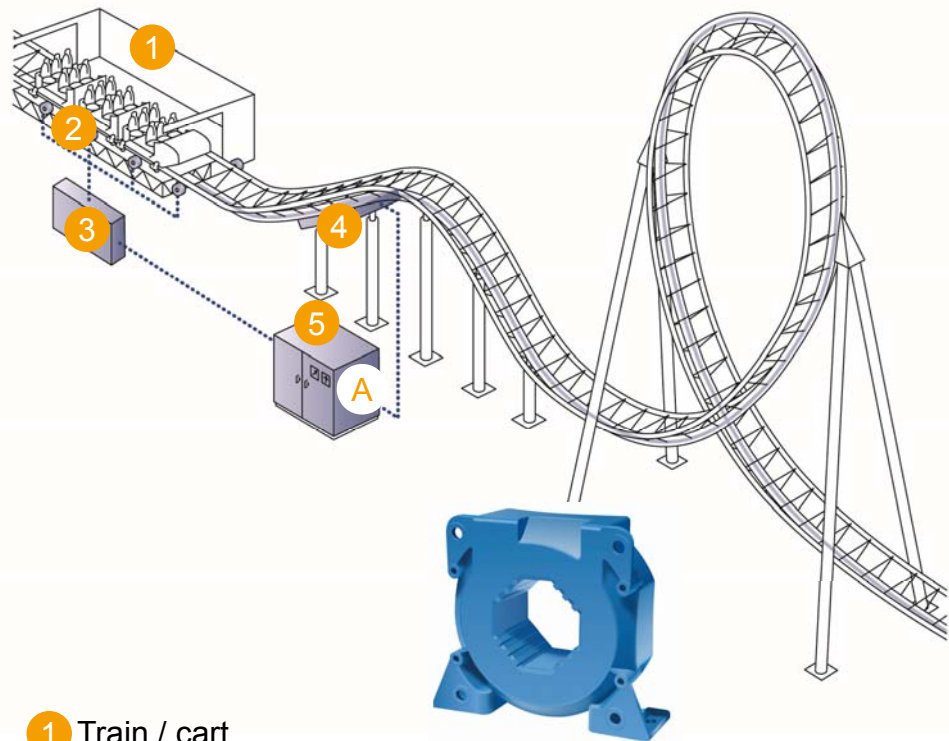

- ① Train / cart
- ② Drive tire
- ③ Inverter for drive tire
- ④ Linear motor
- ⑤ Inverter for linear motor and control unit

A LF 1005-S

Roller coasters use less and less traditional chain lift. The ride is maintained by gravity.

The initial acceleration energy is provided via one or several linear motors (4), catapults, or other mechanisms replacing hydraulic or pneumatic power. In case of linear motors the propulsion of the carts (1) along the track at various stages is managed using electromagnetic fields that require high currents.

These electrical linear motors enable the various torques and accelerations in time and duration. The motors are controlled by electrical drives via the currents supplied. The current transducers (A) give the feedback to the control loop (5) in order to ensure the right accelerations independently of the load and friction of the train.

# 1. LEM Applications: Sewing Machine/Embroidery Machine

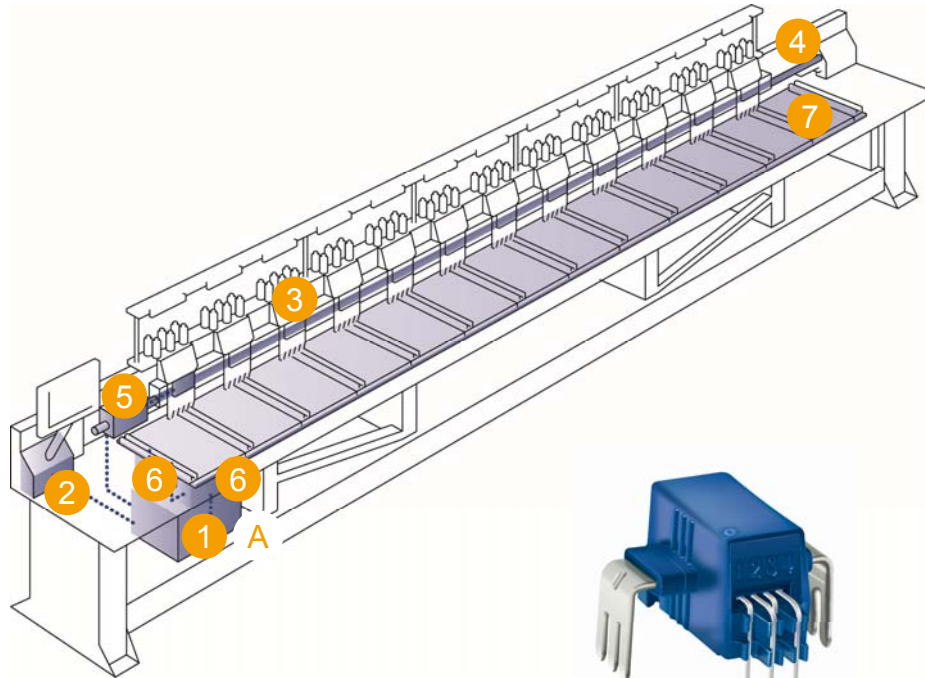

- 1 Servo drives
- 2 Control unit
- 3 Head
- 4 Main axis
- 5 Motor
- 6 Linear motors
- 7 Working table



A HLSR 10-P

Full servo control allows for speed and precision in industrial sewing/embroidery machines.

Accuracy and speed of the table movements, as well as the correct, accurate and regulated rotation speed of the main axis for the needles are directly linked to the currents provided to the motor (5) through a servo drive (1). The working table (7) is moving in horizontal X and Y directions thanks to linear motors (6) controlled by two position servo drives (1).

Current transducers (A) are used in each servo drive to measure two of its three phase output AC currents. Their accuracy, high performance, high temperature working environment, low temperature drift contribute to a very stable, quick, reactive, reliable and precise system.

# 1. Diverse Target Markets – Diversified Businesses

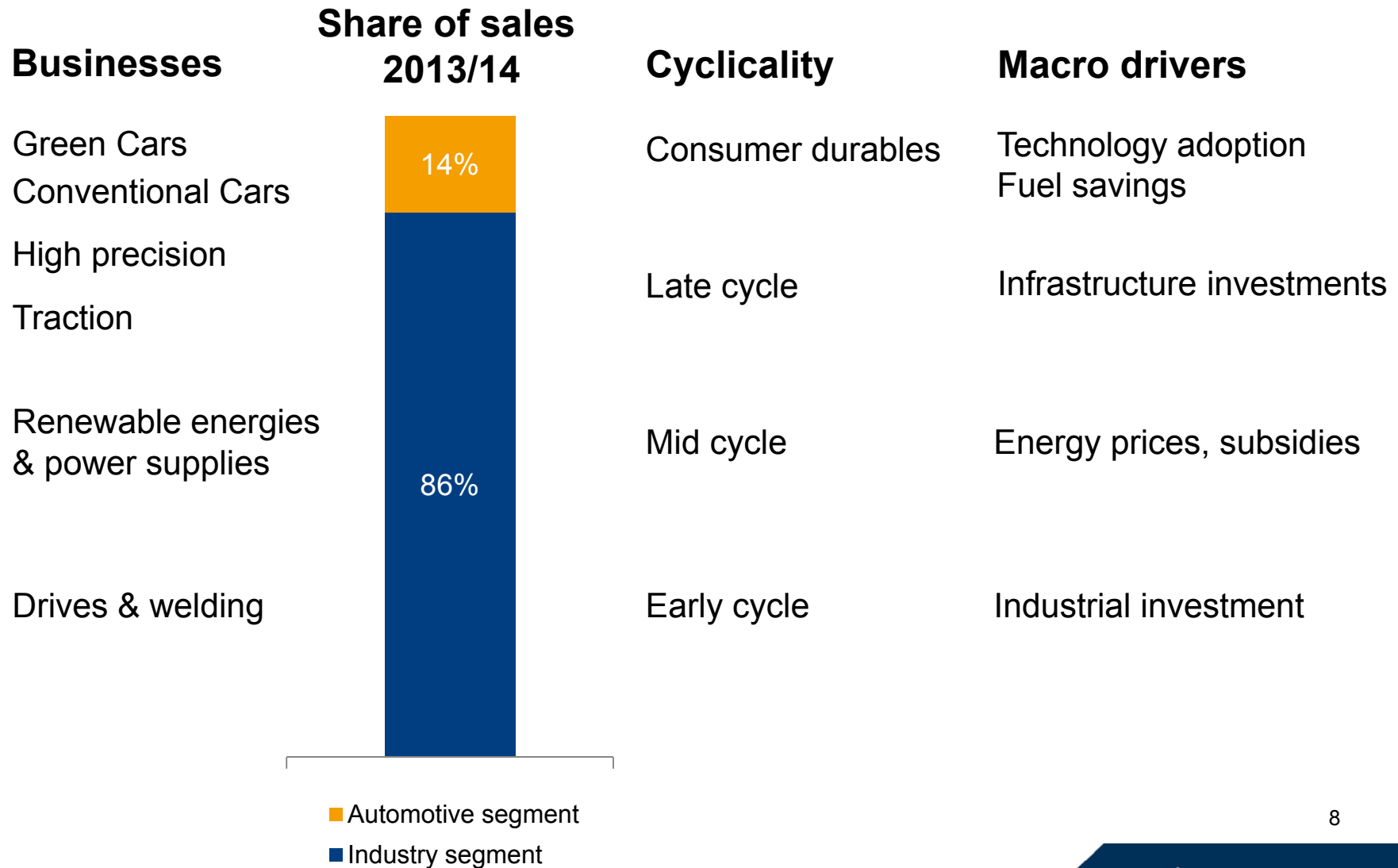



# Agenda

- |  |                         |
|--|-------------------------|
| 1. LEM at a Glance                       | François Gabella        |
| <b>2. Highlights and Business Review</b> | <b>François Gabella</b> |
| 3. Financial Review                      | Julius Renk             |
| 4. Strategy and Outlook                  | François Gabella        |
| 5. Proposals to Shareholders Meeting     | Andreas Hürlimann       |



9

## 2. Highlights 2013/14: Record Profitability

In CHF million, %	2013/14	2013/14 vs. 2012/13*	Q4 vs. Q3 2013/14
Orders	246.4	+6.9%	+8.2%
Sales	245.6	+4.5%	+6.1%
EBIT	55.7	+36.5%	+14.3%
Net profit	45.6	+40.9%	+45.3%

- All-time highs for EBIT margins and net profit
- Solid sales growth in a fragile economic environment
- Ramp-up of production in Sofia, Bulgaria, on track
- Strong price and competitive pressure globally
- Constant high number of product launches

## 2. Eight Product Launches 2013/14 (1/3)

ITL 1200-T



- Extended current range from 900 to 1200 A
- High accurate fluxgate closed loop technology
- Accuracy is expressed in ppm
- Designed for latest versions of MRI



Industry

RT 500



- Rogowski coil measurement technology
- Split-core current sensor for easy installation
- High accuracy regardless the position of the primary conductor by eliminating coil-clasp discontinuity
- High immunity against surrounding perturbations



Industry

TOP 90-S

confidential

- Split-core current sensor for easy mounting
- Cost effective solution for AC non-contact isolated current measurement
- Ideal tool for use with power meters, energy sub-metering in industrial applications



Industry

## 2. Eight Product Launches 2013/14 (2/3)

HO xx-P



- ASIC with twice improved accuracy
- New functionalities: over-current detection, fault reporting function
- PCB-mount design and contactless measurement
- Big hole for cable



Industry

HFWS

confidential

- Customer specific transducer
- Higher current range launching (125 A)
- Communication with microcontroller and serial interface
- Very small size for the current measured



Industry

DVL Voltage Output



- New technology to create digital isolation
- Improved sensitivity to external magnetic fields
- Robust design for harsh environments in traction applications
- Voltage output



Industry

12

## 2. Eight Product Launches 2013/14 (3/3)

HC5 FW



- Open loop transducer
- For inverters, starter generators, converters
- Improved performance at lower price



Automotive

DHAB V2



- Cost effective management of lithium batteries
- For electric and hybrid vehicles



Automotive

## 2. Net Sales

In CHF millions

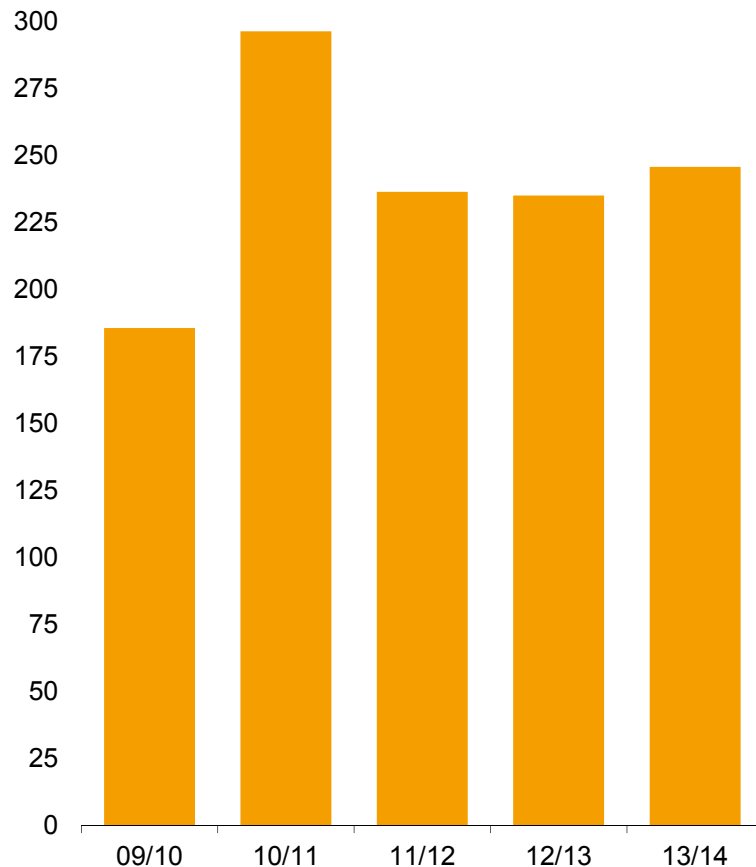

In CHF millions, %	Sales	YoY		Q4 vs. Q3
		as reported	at constant currencies	
Industry	211.1	+5.6%	+7.9%	+8.6%
Automotive	34.6	-1.2%	+2.9%	-7.2%
<b>Total sales</b>	<b>245.6</b>	<b>+4.5%</b>	<b>+7.1%</b>	<b>+6.1%</b>

- Growth contribution from Industry businesses
- Disappointing sales performance in Automotive businesses due to below expectation growth in green cars market
- Negative currency impact on sales

## 2. Quarterly View

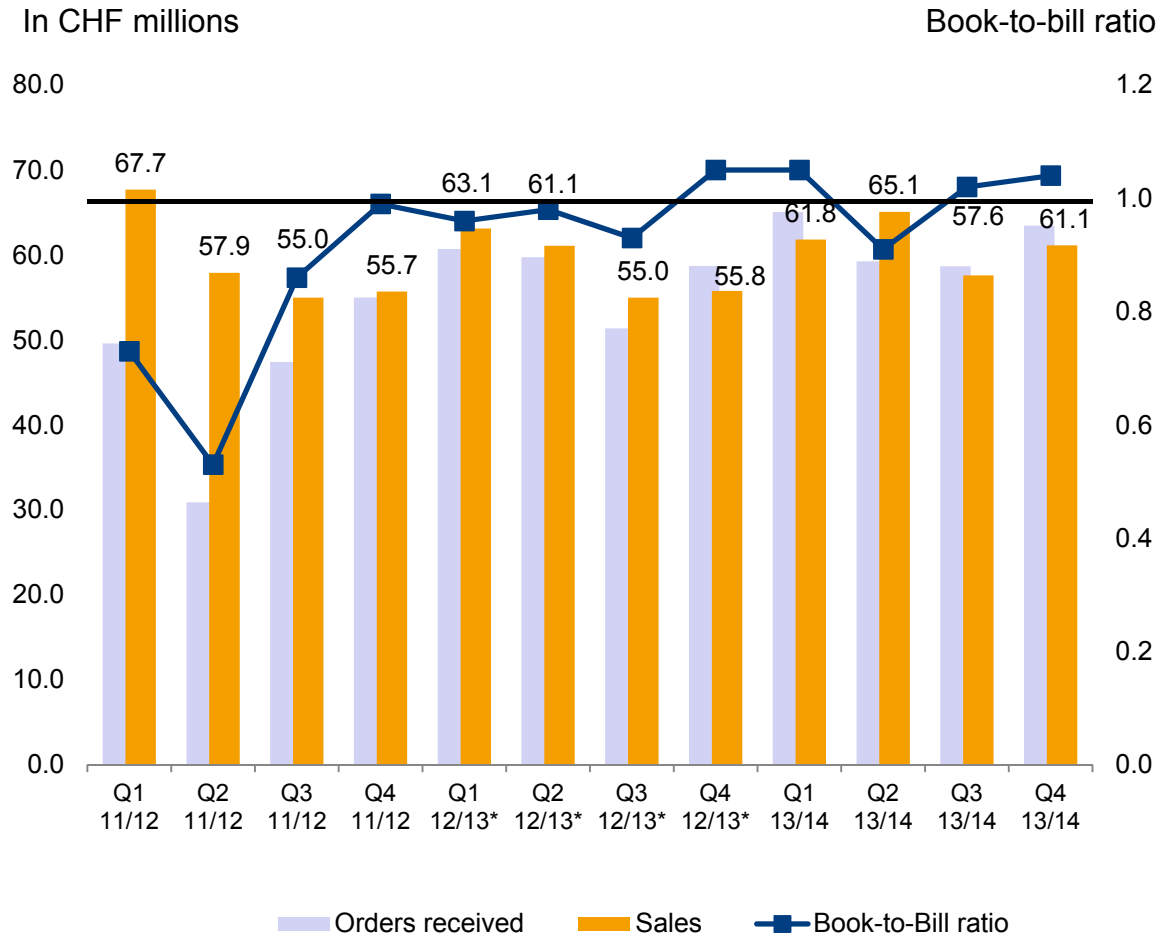

- Stable book-to-bill ratio
- Lead times requested by customers remain short

\* Restatement following IAS 19R application (pensions)

## 2. Industry Segment: Regional Markets

- Europe
- North America
- Asia and ROW

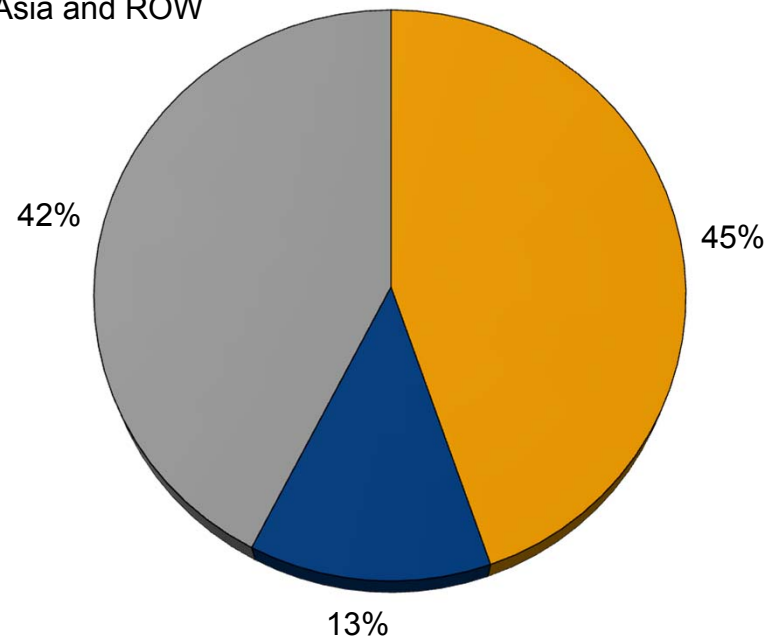

In CHF million, %	Sales	Growth YoY	Growth Q4 vs. Q3
Europe	94.4	-0.9%	+17.5%
N. America	27.1	-4.9%	+17.1%
Asia and ROW	89.6	+17.4%	-2.8%
<b>Total</b>	<b>211.1</b>	<b>+5.6%</b>	<b>+8.6%</b>

- Tailwind from improving economic environment towards end of financial year 2013/14
- Strong growth in China, China expands its #1 position in Industry
- Rebound in Q4 after seasonal decrease in Q3 across Europe and North America

16



## 2. Industry Segment: Business Development

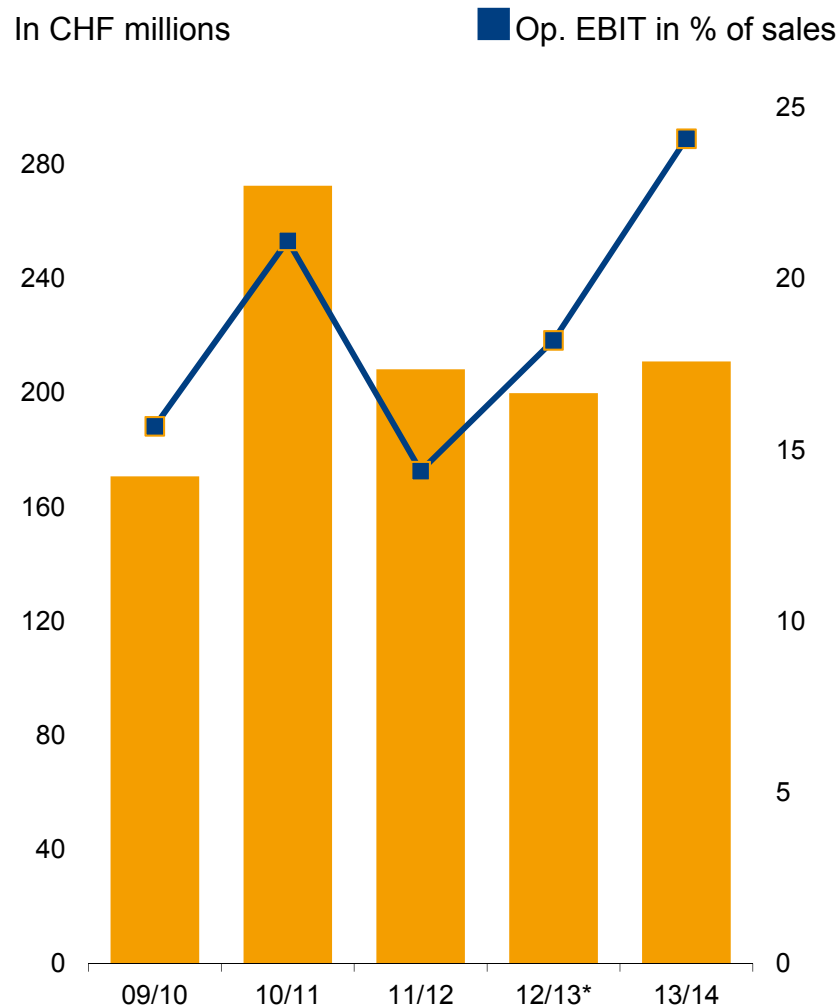

### Businesses and Applications

#### Drives & welding (growth YoY: +10%)

- Market growth in China, good performance in other regions
- Stable market share

#### Renewable energies & power supplies (+6%)

- Investments in renewable energies in China
- Good performance in Wind and UPS
- Pick up of activities in smart-grid applications

#### Traction (-1%)

- Contract wins in India, energy metering in Europa, growth in China
- Low investments in rail infrastructure in Europa

#### High-precision (-10%)

- Weak test and measurement markets
- Medical applications slowed down

17

\* Restatement following IAS 19R application (pensions)

## 2. Automotive Segment: Regional Markets

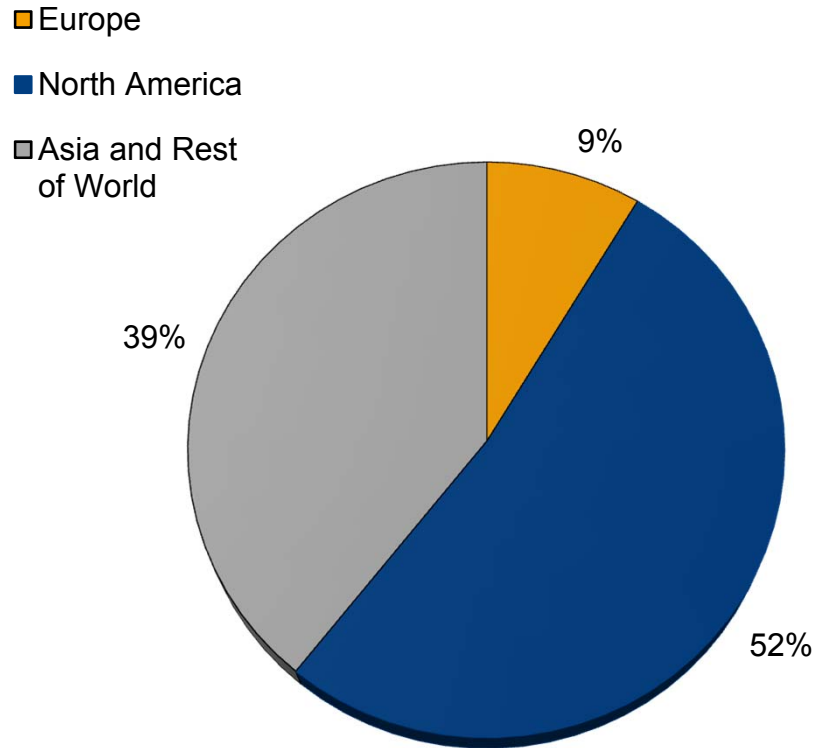

In CHF million, %	Sales	Growth YoY	Growth Q4 vs. Q3
Europe	3.0	+3.1%	-24.7%
N. America	18.0	-0.0%	-5.9%
Asia and ROW	13.6	-3.6%	-4.4%
<b>Total</b>	<b>34.6</b>	<b>-1.2%</b>	<b>7.2%</b>

- Focus on Asian and North American markets
- Negative currency impact in USD and JPY
- Strong growth in China, most other markets stable
- Below expectation growth in green cars

## 2. Automotive Segment: Business Development

In CHF millions ■ Op. EBIT in % of sales

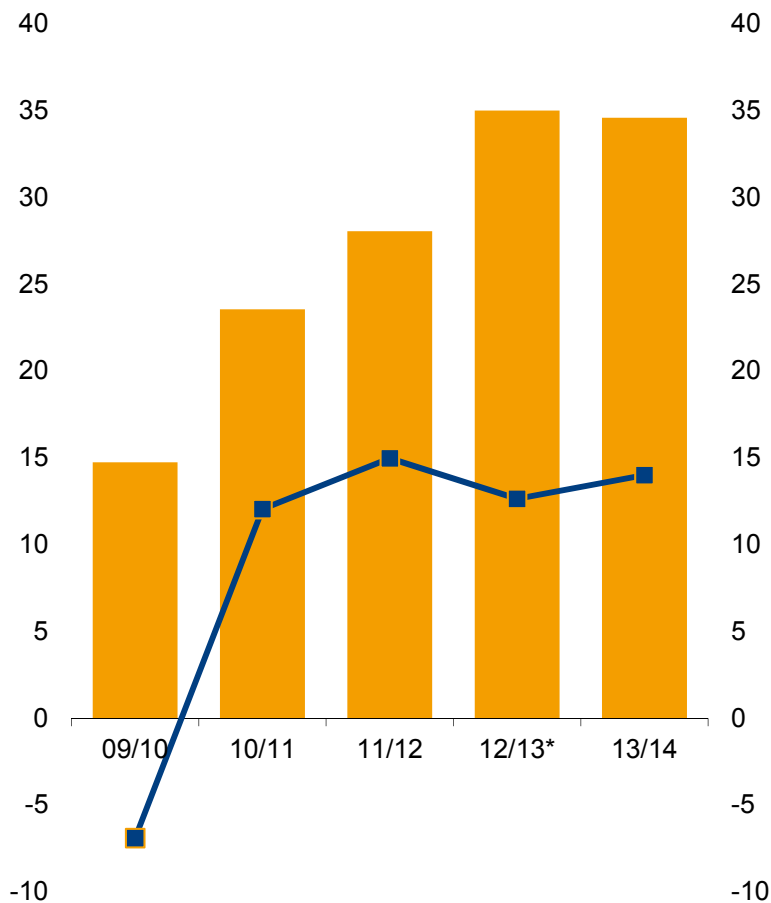

\*Restatement following IAS 19R application (pensions)

### Businesses and Applications

#### Conventional cars (growth YoY: +4%)

- Performance reflects global car markets: flat in Europe, robust performance in Asia and the US
- Solid demand for battery management applications
- Stable start/stop application

#### Green cars (HEV, EV) (-19%)

- Weak general trend
- Higher activity in hybrid cars applications in Europe

## 2. Business Development China

### Sales

- Market share of over 50%
- Biggest market with 23% of total sales

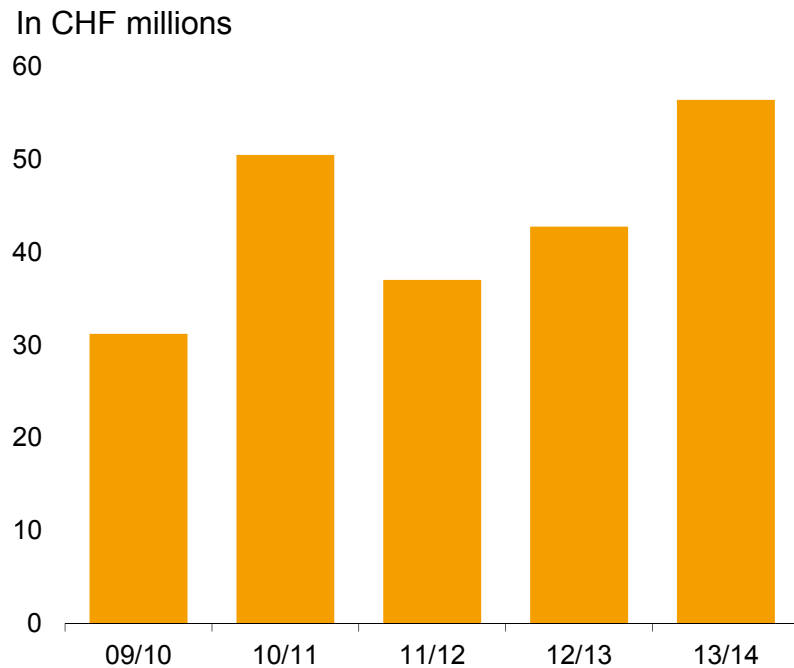

### Production

- LEM China expands its #1 position as largest manufacturing site of the Group (57% of total production, compared to 51% in financial year 2012/13)
- “Made by LEM” quality

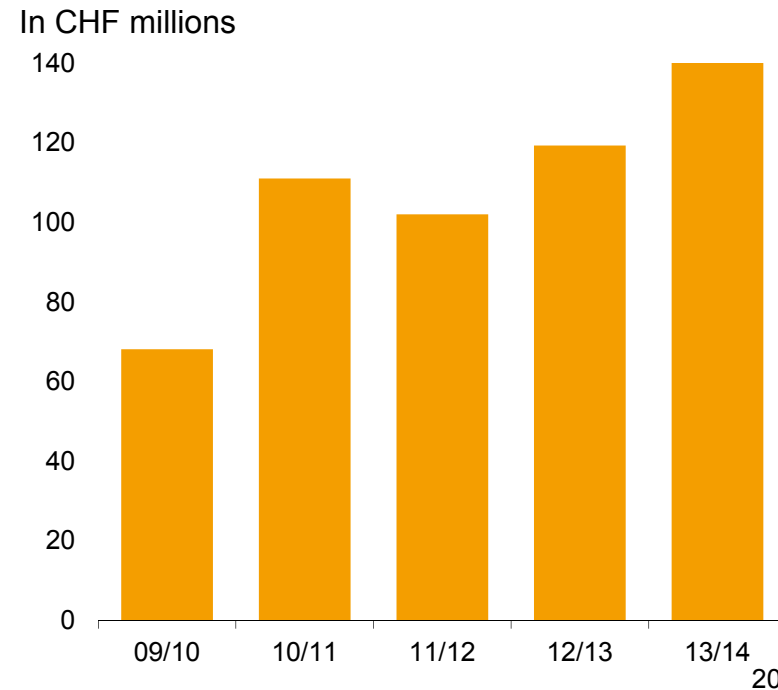

## 2. New Production Site in Sofia (Bulgaria)

- Achievements
  - Investment of CHF 2 million into new site
  - Production started 1 October 2013
  - Delivery approvals from customers received
  - First products delivered to customers
- Objectives of the new site
  - Diversify LEM's cost-competitive production
  - Increase production capacity close to European customers
  - Increase natural hedge of operations
  - Absorb major part of LEM's future growth
- Continuation of strategy initiated in 2004
  - Production lines to be relocated from Machida (Japan) and Geneva (Switzerland) to cost-competitive countries
  - Geneva (Switzerland) site strengthened with investment in R&D and marketing
  - Machida (Japan) site to focus on local Japanese market



# Agenda

- |                                      |                    |
|--------------------------------------|--------------------|
| 1. LEM at a Glance                   | François Gabella   |
| 2. Highlights and Business Review    | François Gabella   |
| <b>3. Financial Review</b>           | <b>Julius Renk</b> |
| 4. Strategy and Outlook              | François Gabella   |
| 5. Proposals to Shareholders Meeting | Andreas Hürlimann  |



22

### 3. Financial Highlights

- All-time high operational profitability at 22.7% on 245.6 million sales
- All-time high net profit for the year at CHF 45.6 million (18.6% of sales)
- Low tax rate of 16.0%
- Strong free cash flow of CHF 31.9 million
- Increase in inventories of CHF 4.9 million to facilitate on-time deliveries

### 3. Balance Sheet Analysis

In CHF millions	31.3.2013*	31.3.2014
Net working capital	23.2	38.7
Fixed assets	36.8	37.8
Noncurrent liabilities	-3.5	-6.9
<b>Net operating assets</b>	<b>56.4</b>	<b>69.6</b>
Net cash / (debt)	27.6	24.6
<b>Equity</b>	<b>84.0</b>	<b>94.2</b>
Equity ratio	61.9%	65.1%
Days of sales outstanding	60	65
Days of inventory outstanding	63	80
Days of payables outstanding	41	49

\* Restatement following IAS 19R application (pensions)



### 3. Income Statement

In CHF millions

	2012/13*	2013/14	Change	Q3 2013/14	Q4 2013/14	Change
<b>Sales</b>	<b>235.0</b>	<b>245.6</b>	<b>+4.5%</b>	<b>57.6</b>	<b>61.1</b>	<b>+6.1%</b>
Gross margin	41.9%	47.0%	+5.0pt	46.5%	48.4%	+1.9pt
Operating exp.	-57.7	-59.6	+3.3%	-14.9	-16.0	+7.6%
<b>EBIT</b>	<b>40.8</b>	<b>55.7</b>	<b>+36.5%</b>	<b>11.9</b>	<b>13.6</b>	<b>+14.3%</b>
Net financial exp.	-1.5	-1.4	-8.9%	-0.9	+0.3	N/A
Income tax	-6.9	-8.7	+26.0%	-2.4	-1.4	-43.1%
<b>Net profit</b>	<b>32.4</b>	<b>45.6</b>	<b>+40.9%</b>	<b>8.6</b>	<b>12.5</b>	<b>+45.3%</b>

25

\*Restatement following IAS 19R application (pensions)

At the heart of power electronics



# 3. Results by Quarter

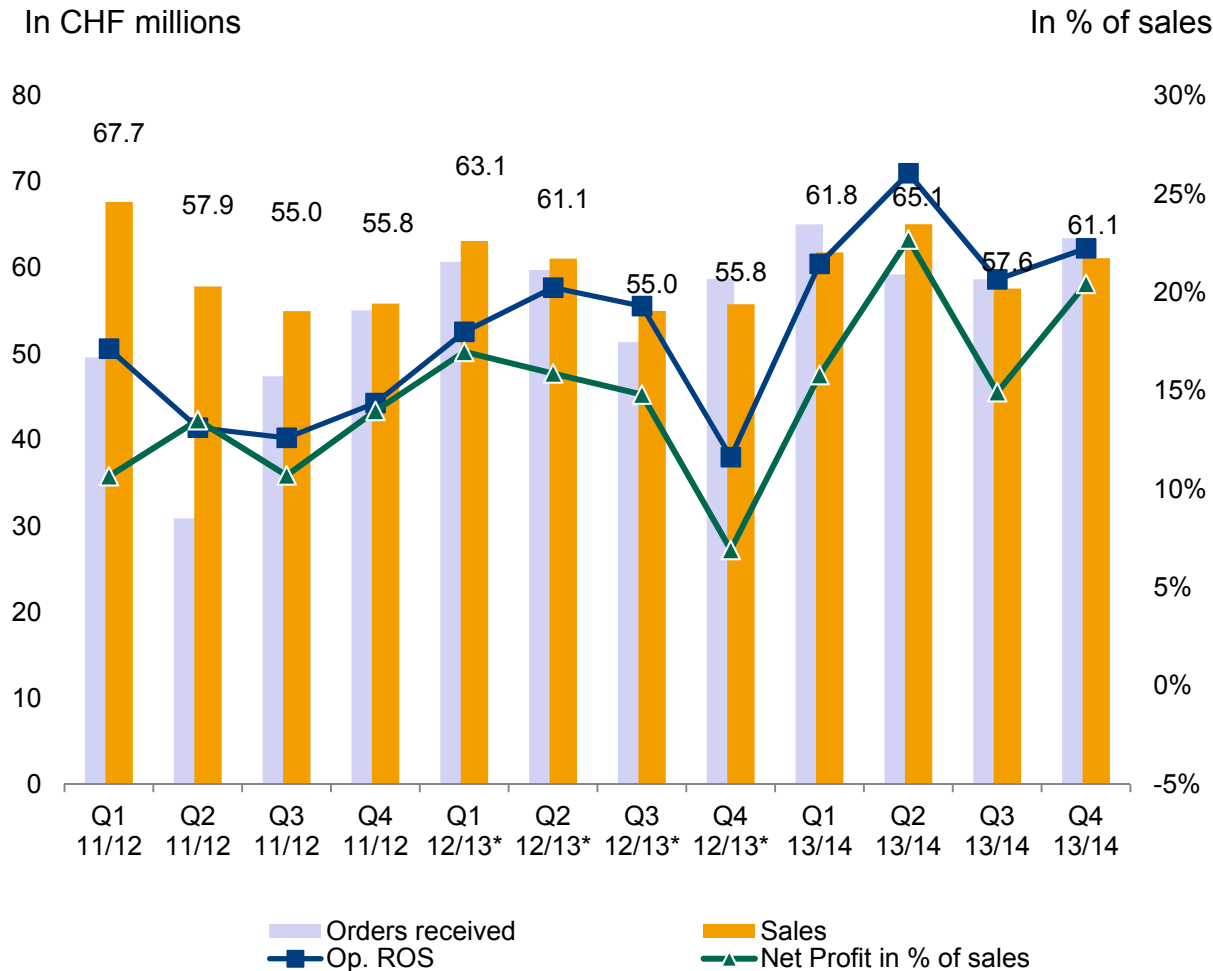

- 2013/14 includes ramp-up cost for Sofia site
- Fourth consecutive quarter with EBIT margin above target range
- Q4 of 2012/13 includes a restructuring charge of CHF 1.9 million

\* Restatement following IAS 19R application (pensions)

# 3. Gross Margin

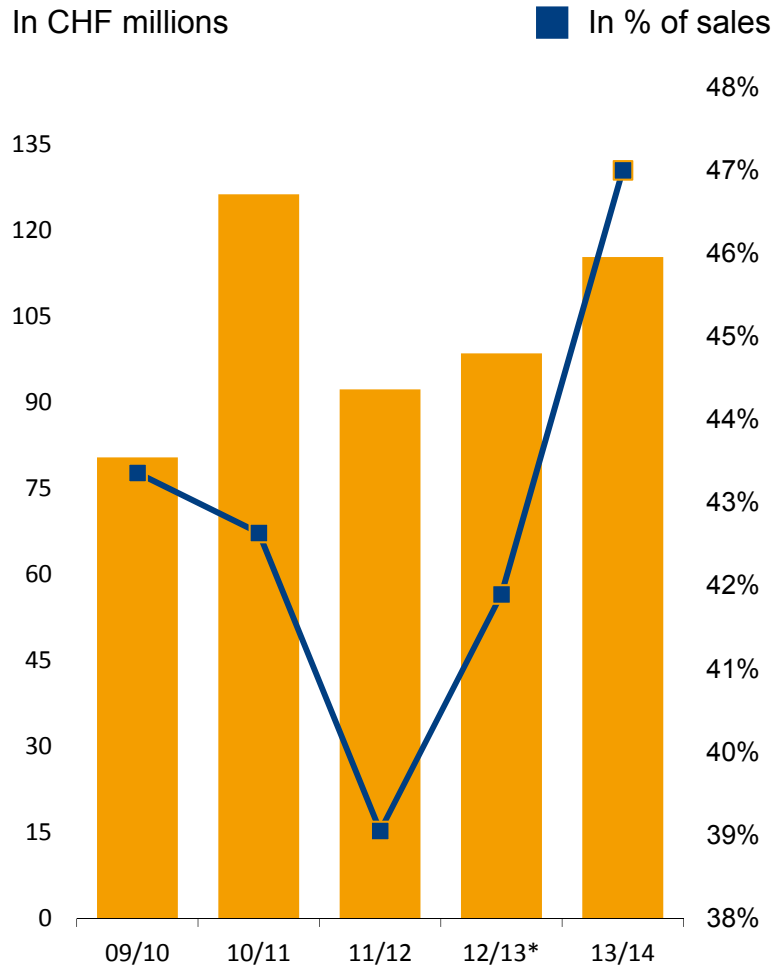

	2012/13*	2013/14	Q3 2013/14	Q4 2013/14
Gross margin in CHF million	98.6	115.4	26.8	29.6
Gross margin in % of sales	41.9%	47.0%	46.5%	48.4%

- Positive impacts on gross margin due to focus on
  - Raw material sourcing
  - Internal productivity
  - Relocation to cost-competitive manufacturing sites

\* Restatement following IAS 19R application (pensions)

# 3. Operating Expense

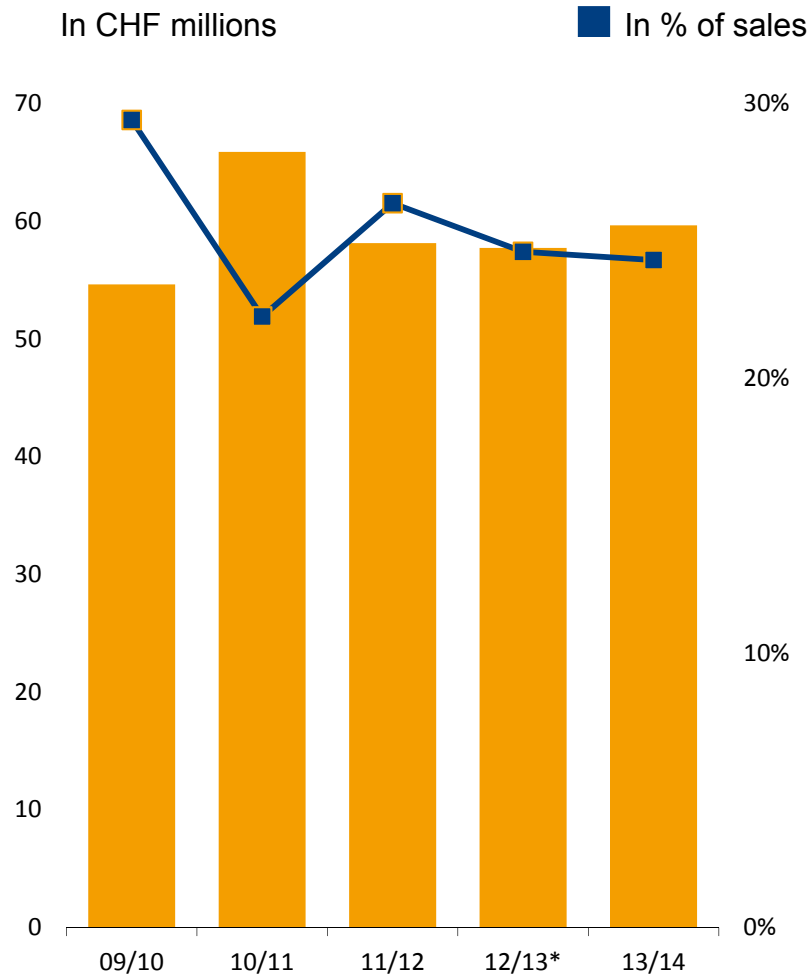

	2012/13*	2013/14	Q3 2013/14	Q4 2013/14
Operating expense in CHF million	57.7	59.6	14.9	16.0
Operating expense in % of sales	24.6%	24.3%	25.8%	26.2%

- Ongoing strict cost control measures
- Operating expense as a percentage of sales remain on low levels compared to historical average
- Includes ramp-up cost for Sofia site

\* Restatement following IAS 19R application (pensions)

# 3. R&D Expense

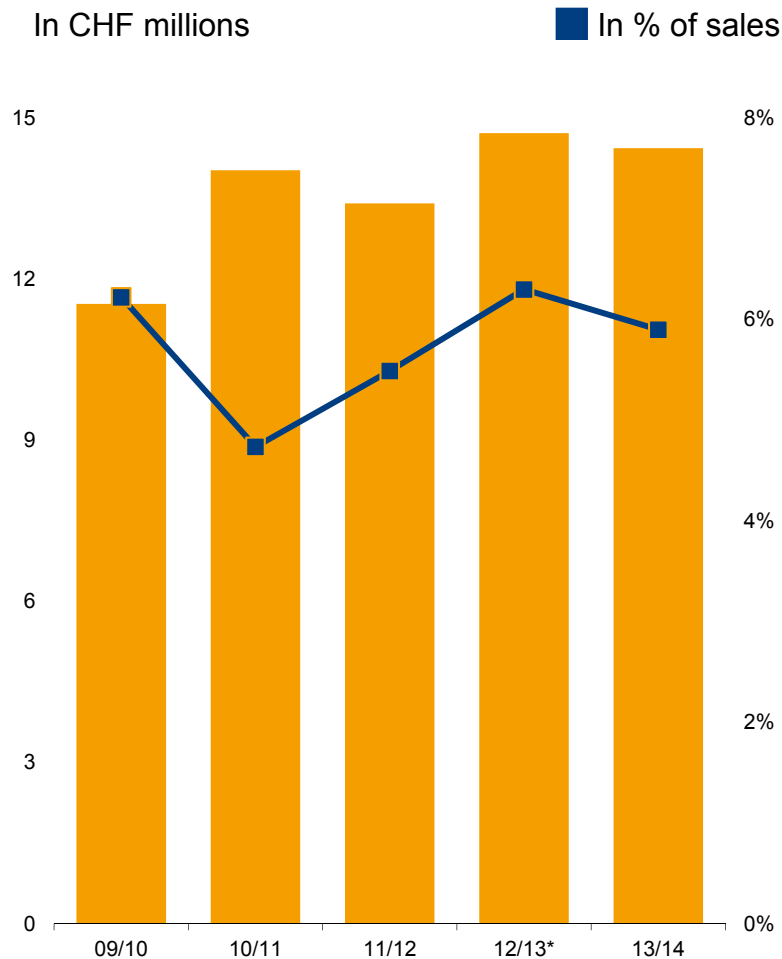

\* Restatement following IAS 19R application (pensions)

	2012/13 *	2013/14	Q3 2013/14	Q4 2013/14
R&D expense in CHF million	14.7	14.4	3.6	3.5
R&D expense in % of sales	6.3%	5.9%	6.2%	5.7%

- Maintained high investment in R&D for both segments
- Ongoing renewal of product range with focus on optimized cost, higher accuracy and new functions
- Above the long term average of 5.5% of sales

# 3. EBIT

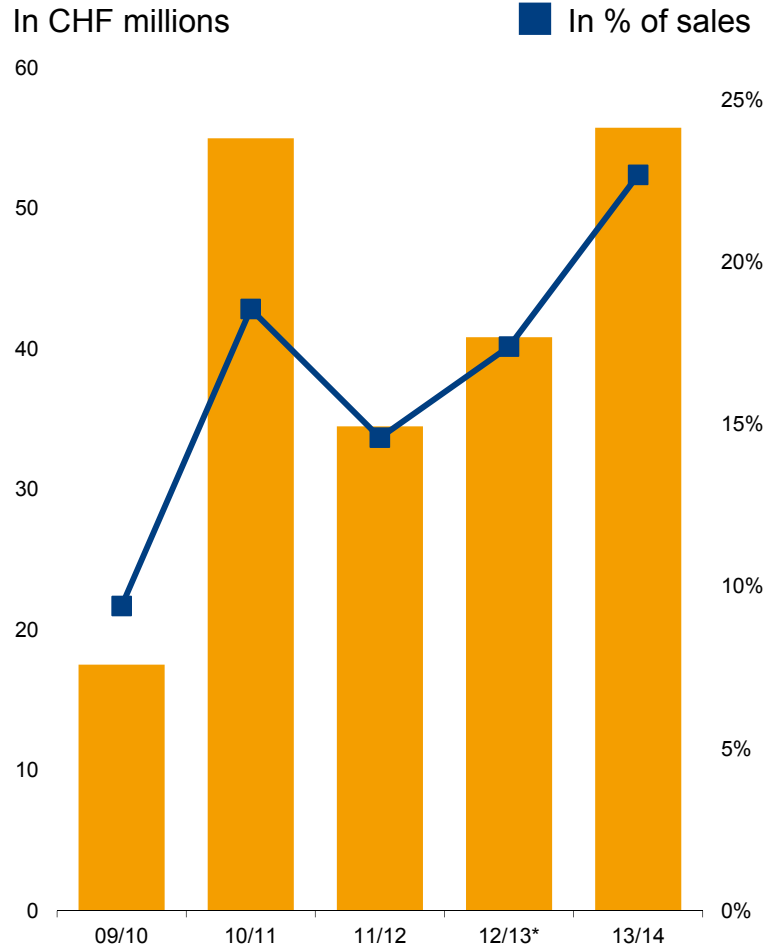

	2012/13*	2013/14	Q3 2013/14	Q4 2013/14
EBIT in CHF million	40.8	55.7	11.9	13.6
EBIT in % of sales	17.4%	22.7%	20.7%	22.2%

- Continued cost control and high gross margins
- In Q3 EBIT margin impacted by lower volumes
- Profitability above target range of 15 to 20%

\* Restatement following IAS 19R application (pensions)

### 3. Financial Expense

In CHF millions

	2012/13 *	2013/14	Q3 2013/14	Q4 2013/14
Exchange effect**	-1.5	-1.4	-0.9	0.2
Other financial expense & income	-0.0	+0.0	-0.0	0.1
<b>Total</b>	<b>-1.5</b>	<b>-1.4</b>	<b>-0.9</b>	<b>0.3</b>

- 2013/14 exchange effect mainly driven by appreciation of CHF vs. USD and JPY
- Foreign exchange hedging policy adapted
  - EUR: 100% of net exposure 12 months forward
  - USD: 100% of net exposure 18 months forward

\* Restatement following IAS 19R application (pensions)

\*\* The line “exchange effect” in the financial result is mainly due to currency volatility during the time between booking and settling a receivable/payable. Over and above this line, foreign exchange rates impact every P&L line through the rate at which each transaction is booked and at which it is consolidated into CHF.

### 3. Income Taxes

	2012/13 <sup>*</sup>	2013/14
Expected income tax rate	15.5%	16.8%
Expected withholding tax rate	2.3%	2.0%
<b>Expected tax rate</b>	<b>17.8%</b>	<b>18.8%</b>
Effect of changes in tax rates on deferred tax	0.1%	-2.9%
Other differences	-0.4%	0.1%
<b>Effective tax rate</b>	<b>17.5%</b>	<b>16.0%</b>

- Slightly higher expected tax rate due to the decision to abandon the HNTE status in China (+0.6%-pts for one quarter)
- One-time positive revaluation effect of change in HNTE tax rate on deferred tax assets
- Substantial reduction of tax rate over the last five years

32

<sup>\*</sup> Restatement following IAS 19R application (pensions)



# 3. Net Profit

In CHF millions

■ In % of sales

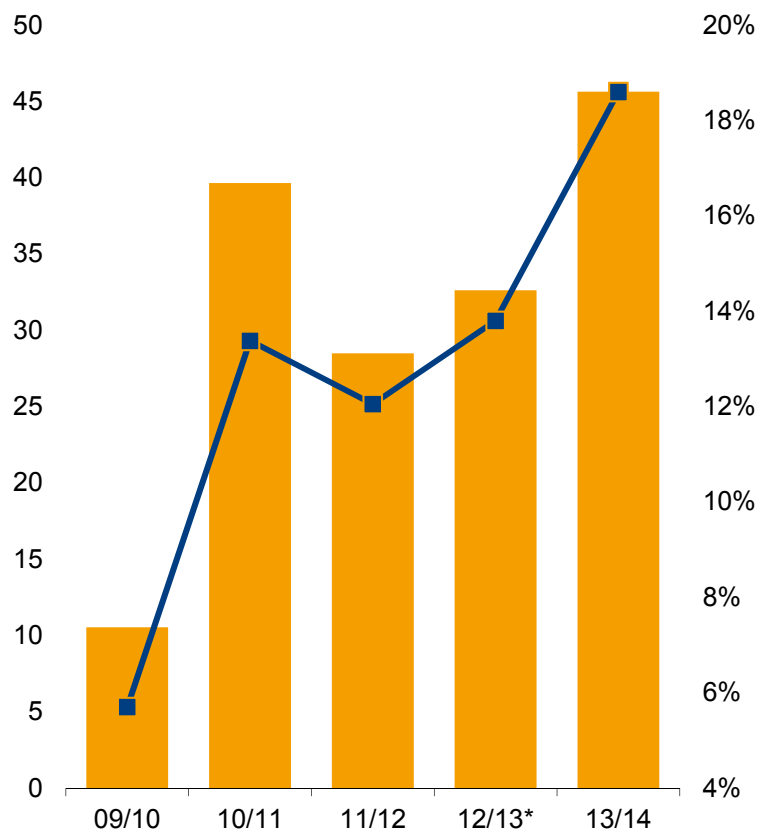

	2012/13*	2013/14	Q3 2013/14	Q4 2013/14
Net profit in CHF million	32.4	45.6	8.6	12.5
Net profit in % of sales	13.8%	18.6%	14.9%	20.4%

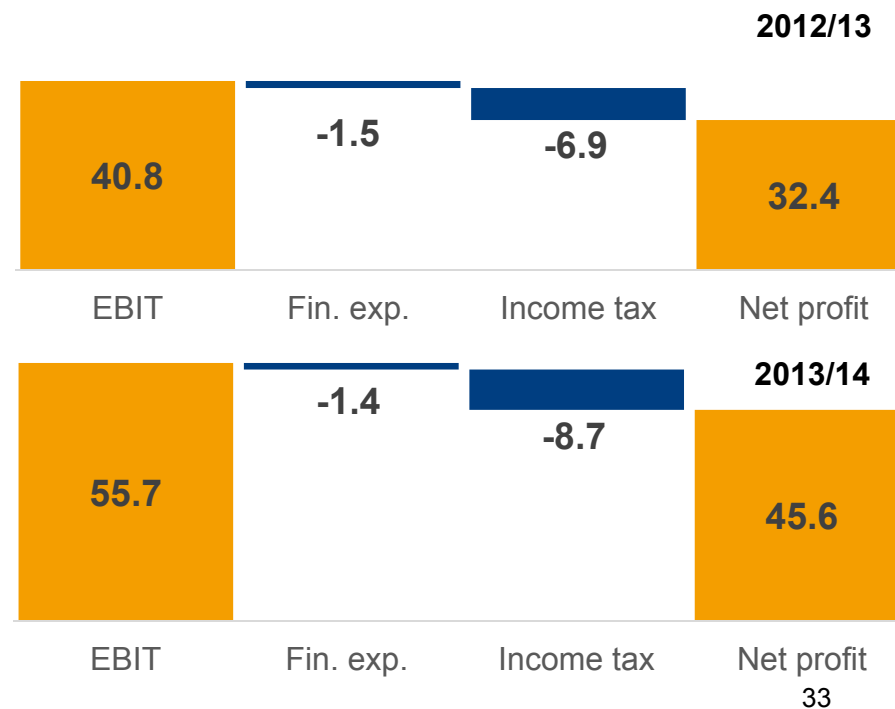

\* Restatement following IAS 19R application (pensions)

### 3. Cash Flow Statement

In CHF millions	2012/13*	2013/14
Profit before taxes	39.3	54.4
Non-cash items	5.1	-5.1
Cash flow from changes in net working capital	1.8	-8.7
<b>Cash flow from operating activities</b>	<b>46.2</b>	<b>40.6</b>
Cash flow from investing activities	-10.4	-8.7
<b>Free cash flow</b>	<b>35.8</b>	<b>31.9</b>
Cash flow from financing activities	-29.9	-34.0
Change in cash and cash equivalents	5.9	-2.2
<b>Cash and cash equivalents at the end of the period</b>	<b>27.6</b>	<b>24.6</b>

34

\* Restatement following IAS 19R application (pensions)

# Agenda

- |                                      |                         |
|--------------------------------------|-------------------------|
| 1. LEM at a Glance                   | François Gabella        |
| 2. Highlights and Business Review    | François Gabella        |
| 3. Financial Review                  | Julius Renk             |
| <b>4. Strategy and Outlook</b>       | <b>François Gabella</b> |
| 5. Proposals to Shareholders Meeting | Andreas Hürlimann       |



35

## 4. Market Factors and Strategy

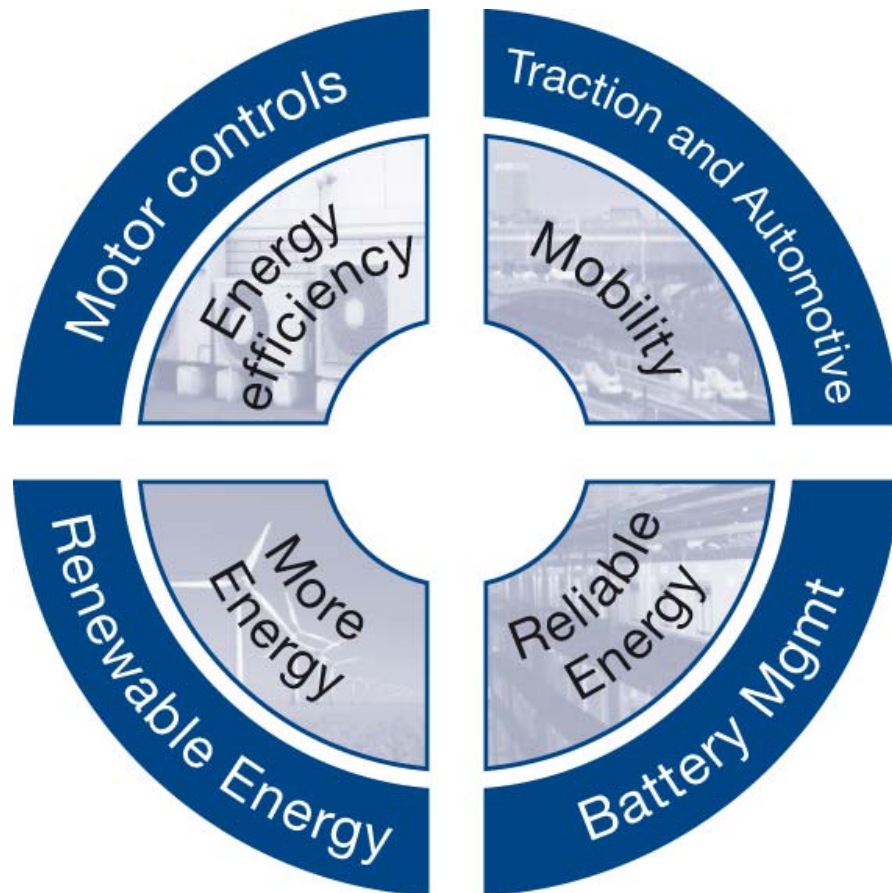

- We firmly believe in our strategic direction and the 4 drivers for our business remain unchanged
- We will continue to capitalize on the drivers of LEM's markets through
  - pure play components company
  - diversification across geographies and businesses

36

## 4. Executing Strategy

---

### Strategic priorities

---

### Achievements in 2013/14

---

#### Increase technology leadership

- Reinforce multidisciplinary innovation team
  - Increase number of product launches
  - Constantly improve performance of products
- Launched 8 new products
  - Worldwide technology survey
  - Developed network of partnerships
- 

#### Increase efficiency

- Reduce product cost through cost-competitive sourcing and manufacturing
  - Reduce complexity of organization
- Established new site in Sofia, Bulgaria
- 

#### Increase production flexibility

- Develop systems to better forecast demand fluctuations
  - Improve supply chain management
- Introduced new forecasting system
  - Maintained high level of flexibility and on-time delivery
- 

37

## 4. Outlook

- Economic perspectives improving with modest pick-up in Europe and North America and robust performance in China
- For 2014/15 we expect
  - Industry segment: well positioned to capitalize on economic improvements and support from new products
  - Automotive segment: resume growth backed by growing global vehicle production and market share gains in the green cars business
  - Competition to remain fierce due to overcapacities in our industry as well as in those of our customers
- Further implementation of our strategic initiatives

# Agenda

- |   |                          |
|---|--------------------------|
| 1. LEM at a Glance                          | François Gabella         |
| 2. Highlights and Business Review           | François Gabella         |
| 3. Financial Review                         | Julius Renk              |
| 4. Strategy and Outlook                     | François Gabella         |
| <b>5. Proposals to Shareholders Meeting</b> | <b>Andreas Hürlimann</b> |



39

## 5. Dividend Proposal

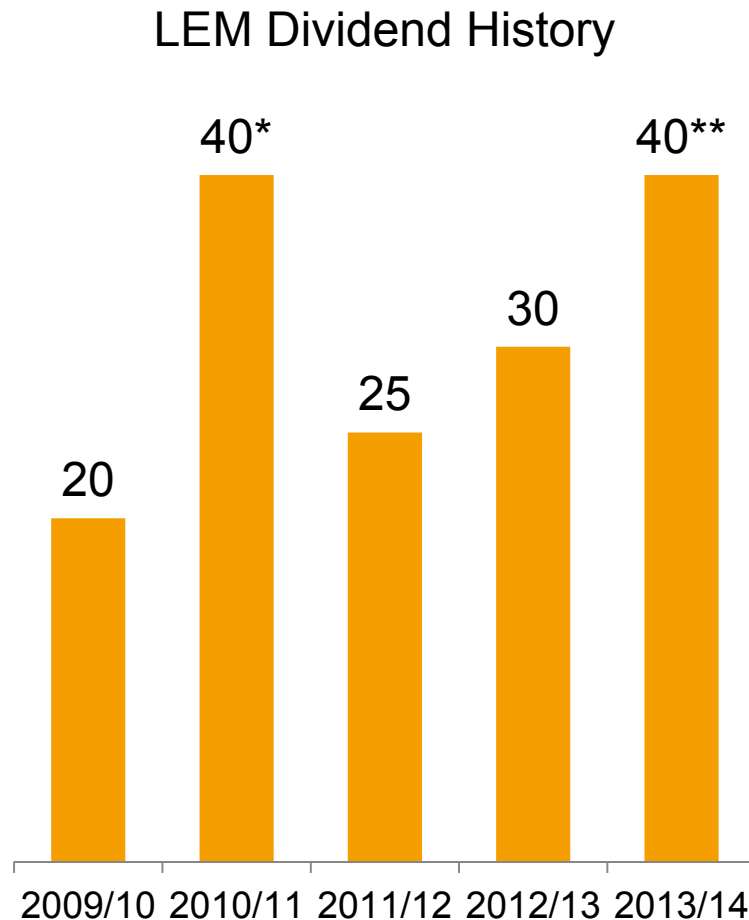

- High trust in the company's capability to generate strong cash flows
- Ordinary dividend of CHF 40 per share
- Payment corresponds to a payout ratio of 99.8%

\* Including CHF 10 from early termination of share buy-back

\*\* Proposal to AGM of 26 June 2014

40



## 5. “Minder” Implementation at LEM – Guiding Principles

- LEM specifics
  - Medium sized company with a matching lean Board of Directors and management structure
  - Board of Directors committees prepare decisions and provide recommendations only, the entire Board of Directors decides and remains responsible
  - Financial year runs from 1 April to 31 March
- Clarify the principles in the Articles of Association and address the details in regulations
- Maintain a sense of proportion, implement pragmatic solutions and consider shareholders’ interest holistically
- Compensation principles
  - Be an attractive and reliable employer for the Executive Management
  - Pay Executive Management for performance and results at market level
  - Board of Directors compensation reflects time dedicated and responsibility

41

# 5. Say-on-Pay – Proposed Approval Process

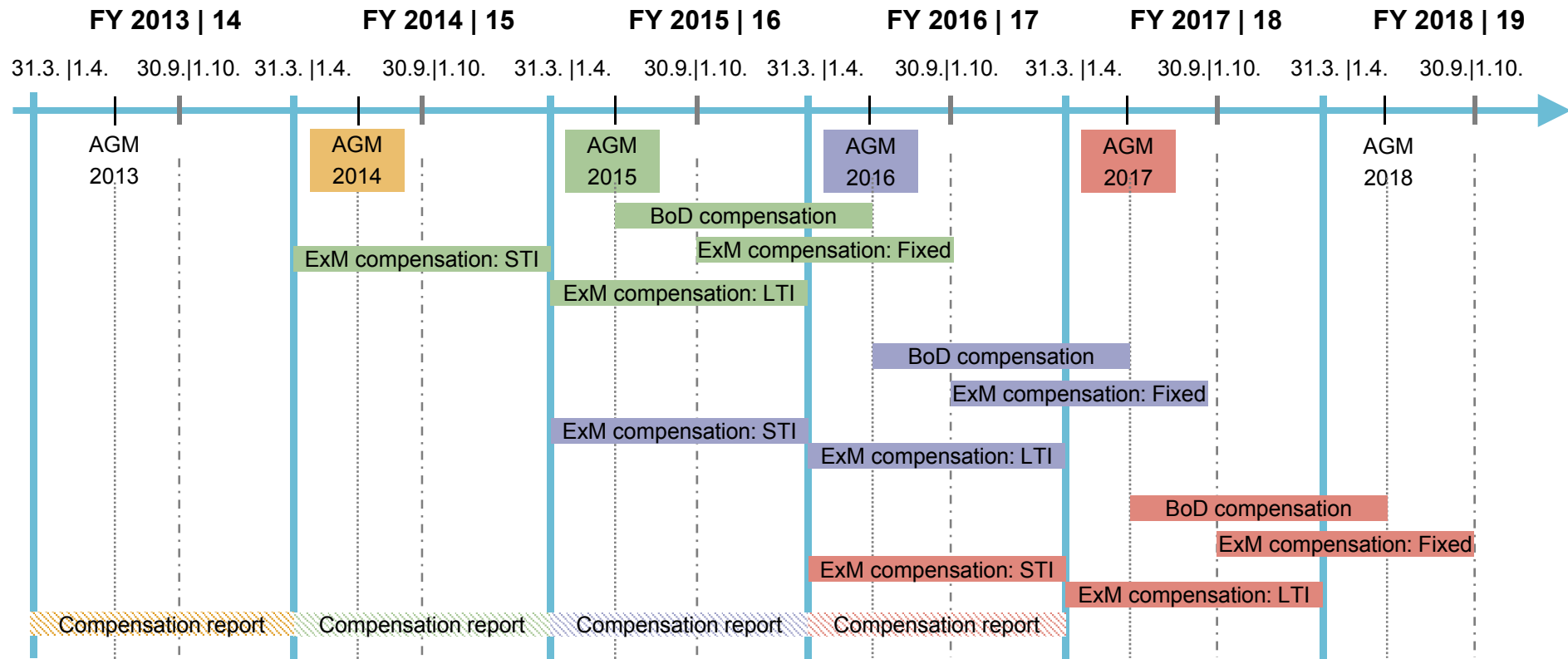

## 5. Proposed Implementation of Other Important Provisions

- Powers and duties of the Compensation Committee
  - Details to be addressed at committee regulation level
  - Compensation Committee can assume other duties, given the small Board of Directors
- Maximum number of external mandates of members of the Board of Directors and Executive Management
  - Board of Directors: maximum 10, of which 4 in listed companies; maximum 6 pro-bono
  - Executive Management: maximum 3, of which 1 in listed company; maximum 3 pro-bono; all subject to Board of Directors approval
- Maximum notice period for contracts with indefinite term is 12 months

# Q&A

# Financial Calendar and Contact Details

## Financial calendar

26 June 2014	Ordinary Shareholders' Meeting for the year 2013/14
1 July 2014	Dividend ex-date
4 July 2014	Dividend payment date
12 August 2014	First quarter 2014/15 results
13 November 2014	Half-year 2014/15 results
17 February 2015	Third quarter 2014/15 results
4 June 2015	Year-end 2014/15 results
25 June 2015	Ordinary Shareholders' Meeting for the year 2014/15
30 June 2015	Dividend ex-date
3 July 2015	Dividend payment date

## For further information

Julius Renk, CFO

Phone: +41 22 706 12 50

Email: [investor@lem.com](mailto:investor@lem.com)